

SKIMMER SFIORATORE LX7 / SKIMMER OVERFLOW LX7

**NEW**

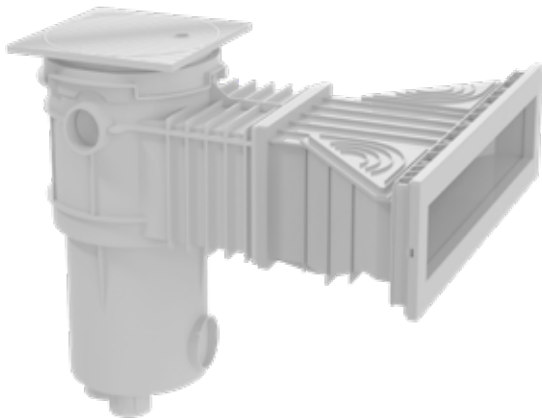

Skimmer sfioratore per piscine con rivestimento in membrana/liner o cemento con **inserti in ottone**, attacco filettato 2". Disponibile guarnizione sandwich per piscine in pannelli in acciaio.

Overflow Skimmer for swimming pools with membrane / liner or concrete lining with **brass inserts** 2" threaded connection. Sandwich gasket for pools in steel panels is available.

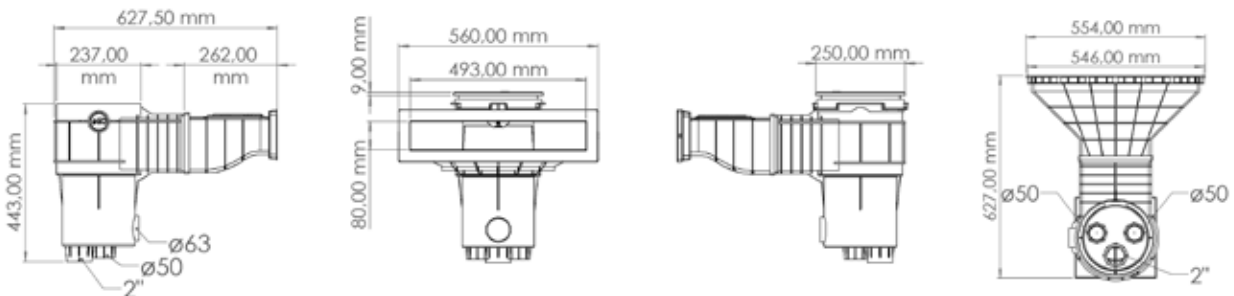

Codice /code	Descrizione /description
2220180	Skimmer sfioratore LX 7 con inserti in ottone per membrana e liner Overflow skimmer LX 7 with brass inserts for membrane and liner pools
1070811	Guarnizione sandwich per skimmer LX7 e LX7 Real Sandwich seal for LX7 and LX7 Real skimmer



Codice /code	2220181	2220182	2220183	2220184	2220185
Colore/color	grigio grey	antracite grey anthracite	celeste light blue	azzurro blue	sabbia sand

BOCCHETTE GM-12 / RETURN FITTINGS GM-12



**NEW**

Bocchetta con passante da 25 cm e getto orientabile anti intrappolamento, per piscina cemento/liner, con attacco ad incollaggio Ø50 mm o filettato maschio da 2". Dotata di **inserti in ottone filettati**.

*Return fitting with 25 cm pass-through and adjustable anti-entrapment jet, for concrete / liner pool, with Ø50 mm glue-in connection or 2" male thread.*

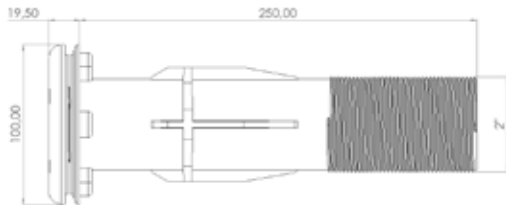

IMPIANTO/EQUIPMENT

Codice /code	Descrizione /description
1072323	Bocchetta GM-12 bianca con passante da 250 mm per liner e getto orientabile Return fitting GM-12 white colour with throughwall 250 mm for liner, with adjustable jet



Codice /code	1072324	1072325	1072326	1072327	1072328
Colore/color	celeste light blue	azzurro blue	grigio grey	sabbia sand	antracite grey anthracite

PRESA SPAZZOLA GM-21 / VACUUM POINT GM-21



**NEW**

Preso a spazzola con passante a parete da 250 mm, con attacco ad incollare Ø50 mm o filetto maschio 2", per piscine con membrana/liner o cemento, con **inserti in ottone filettati**.

Vacuum point with 250 mm wall pass-through, with Ø50 mm glue connection or 2" male thread, for swimming pools with membrane / liner or concrete, with **threaded brass inserts**.

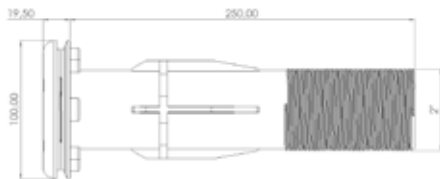

Codice /code	Descrizione /description
1034005	Preso a spazzola GM-21 bianca a parete filettata 2" esterno - diam.50 interno con passante per piscine cemento/liner ugello diam.20 mm" external threaded wall white vacuum point GM-21: - internal diam. 50 with pass-through for concrete pools / liner nozzle diam. 20 mm



Codice /code	1034006	1034007	1034008	1034009	1034010
Colore/color	celeste light blue	azzurro blue	grigio grey	sabbia sand	antracite grey anthracite

PASSANTE DI PARETE SERIE MT-3 / THROUGH WALL FLANGE MT-3

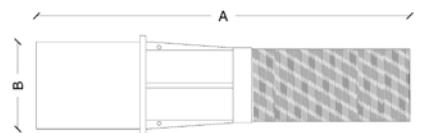

DIMENSIONI / DIMENSIONS

A mm	B mm	C mm
300	63(2")	50

Codice /code	Descrizione /description
2220107	Passante di parete diam. 50 F- 2" M / 2" F / through wall flange Ø 50F- 2" M / 2" F



NEW

BOCCHETTE GM-15 / RETURN FITTINGS GM-15

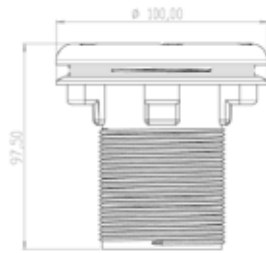

Bocchetta con sfera orientabile anti intrappolamento, idonea a tutti i tipi di struttura, anche pareti sottili, con dado di fissaggio rapido. Per piscine con rivestimento in membrana/ liner, vtr e cemento. Dotata di inserti **filettati in ottone** per una facile e rapida manutenzione nel tempo. Attacco ad incollaggio Ø50 mm o filettato maschio da 2".

*Return fitting with adjustable anti-trapping ball, suitable for all types of structures, even thin walls, with quick fixing nut. For swimming pools with membrane / liner, fiberglass and concrete lining. Equipped with brass threaded inserts for easy and quick maintenance over time. Glue-in connection Ø50 mm or 2" male thread.*



Codice /code	Descrizione /description
1070354	Bocchetta GM-15 bianca con inserti per liner con getto orientabile per cls White GM-15 return fitting with inserts for liner with adjustable jet for concrete wall



Codice /code	1070358	1070359	1070360	1070361	1070362
Colore/color	celeste light blue	azzurro blue	grigio grey	sabbia sand	antracite grey anthracite

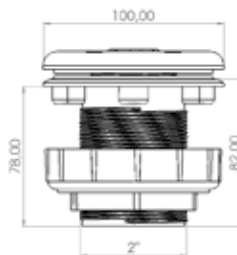

Codice /code	Descrizione /description
1070317	Bocchetta GM-15 bianca con inserti per liner con getto orientabile per cls e parete sottile White GM-15 return fitting with inserts for liner with adjustable jet for concrete and thin wall



Codice /code	1070318	1070319	1070320	1070321	1070322
Colore/color	celeste light blue	azzurro blue	grigio grey	sabbia sand	antracite grey anthracite

IMPIANTO/EQUIPMENT

**BOCCHETTE GM-18 / RETURN FITTINGS GM-18**

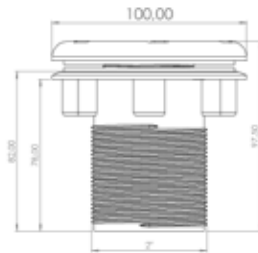

Bocchetta con sfera orientabile anti intrappolamento, idonea a tutti i tipi di struttura, anche pareti sottili, con dado di fissaggio rapido. Per piscine con rivestimento in membrana/ liner, vtr e cemento. Attacco ad incollaggio Ø50 mm o filettato maschio da 2". Doppia serie di fori di fissaggio.

*Return fitting with adjustable anti-trapping ball, suitable for all types of structures, even thin walls, with quick fixing nut. For swimming pools with membrane / liner, fiberglass and concrete lining. Glue-in connection Ø50 mm or 2" male thread. Double series of fixing holes.*



Codice /code	Descrizione /description
1070355	Bocchetta GM-18 bianca per liner con getto orientabile per cls White GM-18 return fitting with inserts for liner with adjustable jet for concrete wall



Codice /code	1070363	1070364	1070365	1070366	1070367
Colore/color	celeste light blue	azzurro blue	grigio grey	sabbia sand	antracite grey anthracite

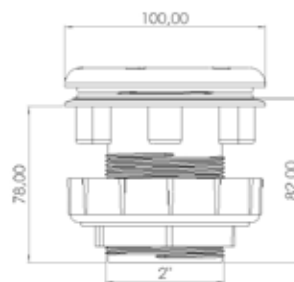

Codice /code	Descrizione /description
1070323	Bocchetta GM-18 bianca senza inserti per liner con getto orientabile per cls e parete sottile White GM-18 return fitting without inserts for liner with adjustable jet for concrete and thin wall



Codice /code	1070324	1070325	1070326	1070327	1070328
Colore/color	celeste light blue	azzurro blue	grigio grey	sabbia sand	antracite grey anthracite

PRESA SPAZZOLA GM-27 / VACUUM POINT GM-27



NEW

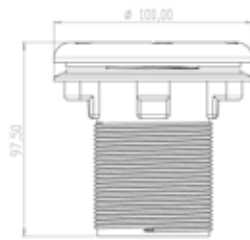

Preso spazzola aspira fanghi, idonea a tutti i tipi di struttura, anche pareti sottili, con dado di fissaggio rapido. Per piscine con rivestimento in membrana/liner, vtr e cemento. Attacco ad incollaggio Ø50 mm o filettato maschio da 2". Dotata di **inserti in ottone filettati**.

Vacuum point sucks sludge, suitable for all types of structures, even thin walls, with quick fixing nut. For swimming pools with membrane / liner, fiberglass and concrete lining. Glue-in connection Ø50 mm or 2" male thread. **Equipped with threaded brass inserts.**



Codice /code	Descrizione /description
1070356	Preso a spazzola GM-27 bianca con inserti per liner con getto orientabile per cls Vacuum point GM-27 with white inserts for liner with swiveling jet for concrete wall



Codice /code	1070368	1070369	1070370	1070371	1070372
Colore/color	celeste light blue	azzurro blue	grigio grey	sabbia sand	antracite grey anthracite

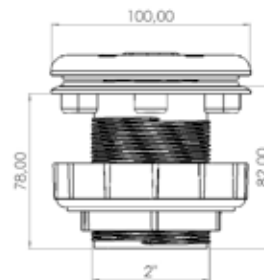

Codice /code	Descrizione /description
1070329	Preso a spazzola GM-27 con inserti bianca per liner con getto orientabile per cls e parete sottile Vacuum point GM-27 with white inserts for liner with swiveling jet for concrete and thin wall



Codice /code	1070330	1070331	1070332	1070333	1070334
Colore/color	celeste light blue	azzurro blue	grigio grey	sabbia sand	antracite grey anthracite

IMPIANTO/EQUIPMENT

**PRESA SPAZZOLA GM-24 / VACUUM POINT GM-24**

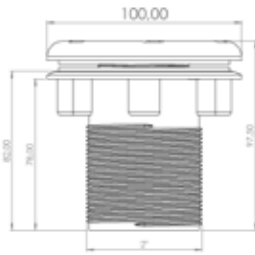

Prespa spazzola aspra fanghi , idonea a tutti i tipi di struttura, anche pareti sottili, con dado di fissaggio rapido. Per piscine con rivestimento in membrana/liner, vtr e cemento. Attacco ad incollaggio Ø50 mm o filettato maschio da 2". **Doppia serie di fori di fissaggio.**

Vacuum point sucks sludge, suitable for all types of structures, even thin walls, with quick fixing nut. For swimming pools with membrane / liner, fiberglass and concrete lining. Glue-in connection Ø50 mm or 2 "male thread. **Double series of fixing holes.**



Codice /code	Descrizione /description
1070357	Prespa a spazzola GM-24 bianca senza inserti per liner con getto orientabile per cls Vacuum point GM-27 white without inserts for liner with swiveling jet for concrete wall



Codice /code	1070374	1070375	1070376	1070377	1070378
Colore/color	celeste light blue	azzurro blue	grigio grey	sabbia sand	antracite grey anthracite

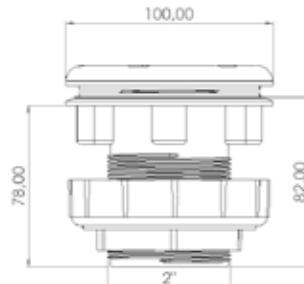

Codice /code	Descrizione /description
1070335	Prespa a spazzola GM-24 senza inserti bianca per liner con getto orientabile per cls e parete sottile Vacuum point GM-24 without white inserts for liner with swiveling jet for concrete and thin wall



Codice /code	1070336	1070337	1070338	1070339	1070340
Colore/color	celeste light blue	azzurro blue	grigio grey	sabbia sand	antracite grey anthracite



**RICAMBI BOCCHETTE E PRESE A SPAZZOLA**  
**SPARE PARTS RETURN FITTINGS AND VACUUM POINT**

600-00501

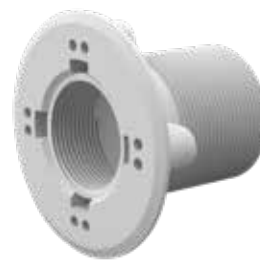

600-00515



Codice /code	Descrizione /description
600-00501	Corpo presa a bocchetta con inserti / return fitting body with inserts
600-00515	Corpo presa a bocchetta senza inserti / return fitting body without inserts
600-811656	Dado filettato 2" / Nut thread 2"
1034011	Kit flangia, guarnizioni e viti serie REAL per inserto
1034012	Kit flangia, guarnizioni e viti serie REAL autofilettanti per inserto

**KIT COPRIFLANGIA E SFERA**

Codice /code	Descrizione /description
1034014	Kit copriflangia e sfera serie REAL bianco



Codice /code	1034015	1034016	1034017	1034018	1034019
Colore/color	celeste light blue	azzurro blue	grigio grey	sabbia sand	antracite grey anthracite

**TAPPO DA 1,5"**

Codice /code	Descrizione /description
600-811661	Tappo 1,5 " bianco



Codice /code	600-811665	600-811666	600-811667	600-811668	600-811669
Colore/color	celeste light blue	azzurro blue	grigio grey	sabbia sand	antracite grey anthracite



**POZZETTO ANTIVORTEX / ANTIVORTEX MAIN DRAIN**



Scarico di fondo conforme alle norme, adatto per installazioni in piscine pubbliche e private fornito di griglia antivortex. Con **inserti in ottone filettati**, in ABS con trattamento anti-UV, connessione di uscita laterale di 2" femmina.

Kit griglia include griglia, guarnizione, flangia e viti.

Main drain compliant with standards, suitable for installations in public and private swimming pools, equipped with anti-vent grid. With threaded brass inserts, in ABS with anti-UV treatment, 2 "female side outlet connection.

Grille kit includes grille, gasket, flange and screws.



Codice /code	Descrizione /description
1070033	Pozzetto di fondo con griglia ANTIVORTEX bianco per liner Main drain with ANTIVORTEX white grid for liner



Codice /code	1070038	1070039	1070042	1070043	1070044
Colore/color	celeste light blue	azzurro blue	grigio grey	sabbia sand	antracite grey anthracite

**RICAMBI / SPARE PARTS**

**KIT GRIGLIA PER POZZETTO ANTIVORTEX**

Codice /code	Descrizione /description
1072285	Griglia bianca per pozzetto di fondo ANTIVORTEX White grid for main drain ANTIVORTEX
1072276	Kit griglia bianco per pozzetto di fondo ANTIVORTEX con guarnizioni, flangia, griglia eviti White grid kit for ANTIVORTEX main drain with con gaskets ,flange,grid screws



Codice /code	1072271	1072272	1072274	1072273	1072275
Colore/color	celeste light blue	azzurro blue	grigio grey	sabbia sand	antracite grey anthracite

POZZETTI DI FONDO A GRIGLIA PIANA GM-30  
MAIN DRAIN GM-30 FLAT GRIP

NEW



Scarico di fondo con griglia piana\*, in ABS con trattamento UV, adatto per installazioni in piscine pubbliche e private. Con **inserti in ottone filettati**, in ABS con trattamento anti-UV. Connessione di uscita laterale filettata femmina da 2". Kit griglia include griglia, guarnizione, flangia e viti.

Main drain with flat grid \*, in ABS with UV treatment, suitable for installations in public and private swimming pools. With threaded brass inserts, in ABS with anti-UV treatment. 2 "female threaded side outlet connection. Grille kit includes grille, gasket, flange and screws.



Codice /code	Descrizione /description
1070347	Pozzetto di fondo GM-30 bianco con griglia piana per liner */ White main drain GM-30 with flat grid for liner *

\* conformità garantita unicamente dall'installazione di due unità in parallelo/ compliance guaranteed only by installing two units in parallel



Codice /code	1070348	1070349	1070350	1070351	1070352
Colore/color	celeste light blue	azzurro blue	grigio grey	sabbia sand	antracite grey anthracite

## RICAMBI / SPARE PARTS

## KIT GRIGLIA PER POZZETTO DI FONDO GM-30

Codice /code	Descrizione /description
1070011	Griglia piana bianca per pozzetto di fondo/White flat grid for main drain
1070353	Kit griglia bianco per pozzetto di fondo con guarnizioni, flangia, griglia eviti/ White grid kit for main drain with gaskets, flange, grid screws



Codice /code	1072330	1072331	1072333	1072332	1072334
Colore/color	celeste light blue	azzurro blue	grigio grey	sabbia sand	antracite grey anthracite

**ASPIRAZIONE PER IMPIANTI IDROMASSAGGIO GM-9  
SUCTION FOR HYDRO INSTALLATIONS GM-9**

**REAL**



**NEW**



Aspirazione, per parete o fondo, idonea per tutti i tipi di struttura e rivestimenti, membrana/liner e cemento, con **inserti in ottone**, attacco per incollaggio da Ø63 mm o filettato maschio da 2.5".

Suction, for wall or bottom, suitable for all types of structures and coatings, membrane / liner and concrete, with **brass inserts**, Ø63 mm bonding connection or 2.5 male thread.



Codice /code	Descrizione /description
1070740	Aspirazione senza dado di serraggio GM-9 bianca Suction without tightening nut GM-9 white



Codice /code	1070741	1070742	1070743	1070744	1070745
Colore/color	celeste light blue	azzurro blue	grigio grey	sabbia sand	antracite grey anthracite

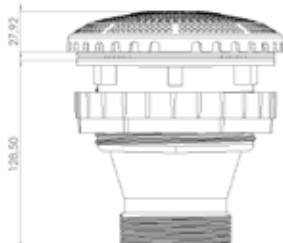

Aspirazione, per parete o fondo, idonea per ogni struttura, pannelli d'acciaio, vasche in vetroresina e rivestimenti, membrana/liner e cemento, con **inserti in ottone**, attacco per incollaggio da Ø63 mm o filettato maschio da 2.5".

Suction, for wall or bottom, suitable for any structure, steel panels, fiberglass tanks and coatings, membrane / liner and concrete, with **brass inserts**, Ø63 mm bonding connection or 2.5 male thread.



Codice /code	Descrizione /description
1070341	Aspirazione con dado di serraggio GM-9 bianca Suction with tightening nut GM-9 white



Codice /code	1070342	1070343	1070344	1070345	1070346
Colore/color	celeste light blue	azzurro blue	grigio grey	sabbia sand	antracite grey anthracite

## RICAMBI ASPIRAZIONE GM-9/ GM-9 SUCTION SPARE PARTS

### KIT VITI, FLANGIA, GUARNIZIONI E DADO DI SERRAGGIO



Codice /code	Descrizione /description
600-120001	Kit viti, flangia e guarnizioni GM-9 kit screws, flange and gaskets GM-9
600-00514	Dado di serraggio GM-9 / GM-9 Nut

### GRIGLIA PER ASPIRAZIONE IDROMASSAGGIO

Codice/code	Descrizione/description
1070074	Griglia per impianti idromassaggio GM-9 bianca/ Grid for hydro installations GM-9 white

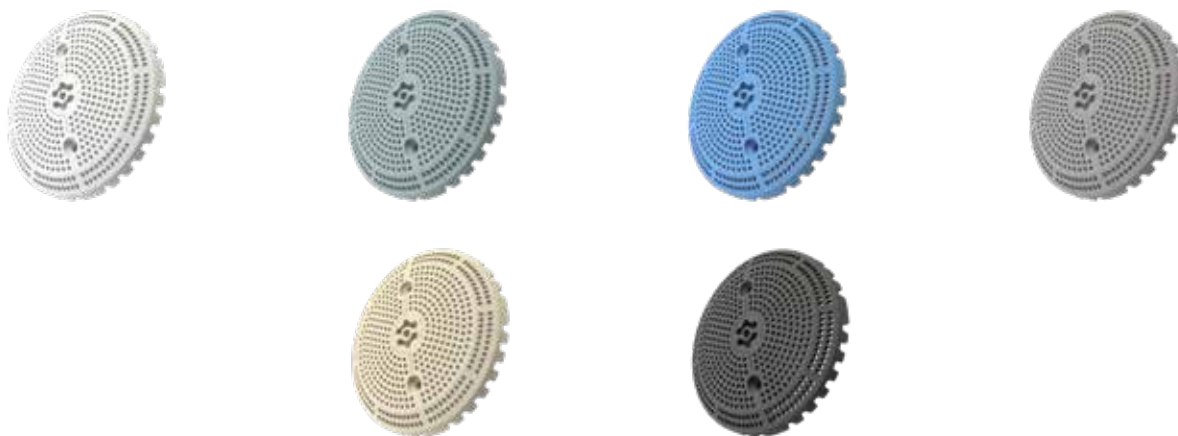

Codice /code	1070075	1070076	1070077	1070079	1070080
Colore/color	celeste light blue	azzurro blue	grigio grey	sabbia sand	antracite grey anthracite

## SKIMMER IN ABS PER LINER / ABS SKIMMER FOR LINER



Gli skimmer possono essere forniti con coperchio e collare color sabbia.

Fornitura di: guarnizione in gomma adesiva, 2 uscite laterali da incollare Ø63 (permettono la posa del regolatore di livello o di un troppo-pieno), protezione adesiva per cantiere, cestello con incastro nel corpo dello skimmer, coperchio auto-bloccante, attacco tubazione filettato 1"½ e 2", cornice del coperchio regolabile in altezza per il livello piastrelle, tubo di troppo-pieno Ø50, astina del cestello in plastica, copri-flangia, possibilità di contenere un regolatore di livello automatico, arresto bloccaggio dell'aletta, ferma l'aletta e minimizza il rumore, possibilità di fissaggio su parete sottile o pannello prefabbricato.

Supply of: rubber adhesive, 2 side outlets Ø63 to glue (allowing the installation of level controller or a too-full), adhesive backing, for construction site, joint basket in the skimmer body, self-locking lid, hose threaded 1 ½" and 2", frame cover adjustable in height to the level tiles, overflow pipe Ø50, rod of plastic basket, cover flange, possibility of contain an automatic level control, stop locking wing, the tab stops and minimizes the noise, the possibility of fixing on thin wall or prefabricated panels.



cod.1070008



cod.1070230



cod.1070217

Codice/ code	Descrizione/description
1070007	Skimmer a bocca standard + prolunga profondità 186 mm - rif. C-111-M / Skimmer standard mouth + extension throat 186 mm - ref. C-111-M
1070008	Skimmer a bocca standard + prolunga profondità 331 mm - rif. C-115-M / Skimmer standard mouth + extension throat 331 mm - ref. C-115-M
1070009	Skimmer a bocca svasata profondità 186 mm - rif. C-117-M / Skimmer wide mouth + extensionthroat 186 mm - ref. C-117-M
1070230	Skimmer a bocca svasata + prolunga profondità 330 mm - rif. C-119-M con inserti in ottone / Skimmer wide mouth + extension throat 330 mm with brass inserts - ref. C-119-M
1070217	Skimmer ONE sfioratore a bocca svasata + prolunga - rif. C-119-Mi-Mrcon / Overflow skimmer ONE with wide mouth + extension throat with brass inserts - ref. C-119-Mi-MR
1070016	Skimmer copertura automatica, liner + 2 prolunghe / Skimmer for automatic cover, liner, 2 extension throw 457 mm - ref. C-119CA-M-2
1070212	Skimmer copertura automatica, liner, ONE sfioratore + 2 prolunghe - rif. C-119-CA-MR / Skimmer for automatic cover, liner, ONE overflow, 2 extension throw - ref. C-119-CA-MR

## SKIMMER PER PISCINA PANNELLI / SKIMMER FOR PANELS



cod.1070220



cod.1070216

Codice / code	Descrizione /description
1070216	Skimmer ONE sfioratore per piscina pannelli/liner- / Overflow skimmer ONE for panel/liner pool - ref. C-119-P-MR
1070220	Skimmer a bocca svasata per piscina pannelli/liner - rif. C-117-P / Skimmer a bocca svasata per piscina pannelli/liner - rif. C-117-P
1070213	Guarnizione sandwich / Sandwich seal

## SKIMMER ARMONIA PERFETTA COLORED SKIMMER

Componete la vostra piscina abbinando il rivestimento agli accessori da murare. I colori si armonizzano perfettamente, conferendo un'estetica raffinata. Oppure per una personalizzazione e un dinamismo, giocate con i contrasti.

*Compose your pool accessories matching the lining and the accessories. The colors blend perfectly, giving a refined aesthetic. Or for customization and dynamism, play with contrasts.*



Descrizione
Skimmer a bocca svasata + prolunga - colorato colored wide mouth skimmer + extension throat
Skimmer ONE sfioratore a bocca svasata + prolunga - colorato colored wide mouth skimmer ONE + extension throat

### Skimmer a bocca svasata + prolunga - colorato /Colored wide mouth skimmer + extension throat

Codice/code	1072000	1072010	1072030	1072040	1072110	1072050
Colore/color	celeste/ light blue	azzurro/ blue	sabbia/sable	grigio/ gray	antracite/ anthracite	nero/ black

### Skimmer ONE sfioratore a bocca svasata + prolunga - colorato/Colored wide mouth skimmer ONE + extension throat

Codice/code	1072160	1072158	1072164	1072161	1072163	1072162
Colore/color	celeste/ light blue	azzurro/ blue	sabbia/sable	grigio/ gray	antracite/ anthracite	nero/ black

## ACCESSORIO SKIMMER / SKIMMER ACCESSORY



Codice /code	Descrizione /description
1070222	Collare compensatore Compensator collar

## REGOLATORE DI LIVELLO / MECHANICAL FLOAT LEVEL CONTROLLER



Meccanismo di carico; coperchio e cornice identici allo skimmer; rapidità di raccordatura Ø50/63. I regolatori di livello sono completi di galleggiante interno meccanico, smontabile dall'interno.

*Loading mechanism, cover and frame identical to the skimmer; fast jointing Ø50/63. The level regulators are equipped with internal mechanical floating, removable from the inside.*

Codice /code	Descrizione /description
1070110	Regolatore di livello completo di galleggiante idraulico 3/8 Mechanical float level controller with floating hydraulic



**COPRI-CORNICE COLORATA ARMONIA PERFETTA, COMPLETA DI ALETTA**  
**COLORED COVER FRAME COMPLETE WITH FLAP**



**per skimmer a bocca svasata/for wide mouth skimmer**

Codice/ code	1072120	1072121	1072123	1072124	1072125	1072126	1073127	1072108
Colore/Color	celeste/light blue	azzurro/blue	sabbia/sable	grigio/gray	antracite/anthracite	nero/black	blu grigio/blue gray	argilla/clay

**per skimmer one/ for skimmer one**

Codice/ code	1072167	1072165	1072171	1072168	1072170	1072169	1072148	1072151
Colore/Color	celeste/light blue	azzurro/blue	sabbia/sable	grigio/gray	antracite/anthracite	nero/black	blu grigio/blue gray	argilla/clay

**FLANGIA, GRIGLIA E GUARNIZIONI ARMONIA PERFETTA BOCCHETTA C-319**  
**COLORED FLANGES, GRATINGS AND GASKETS JET C-319**

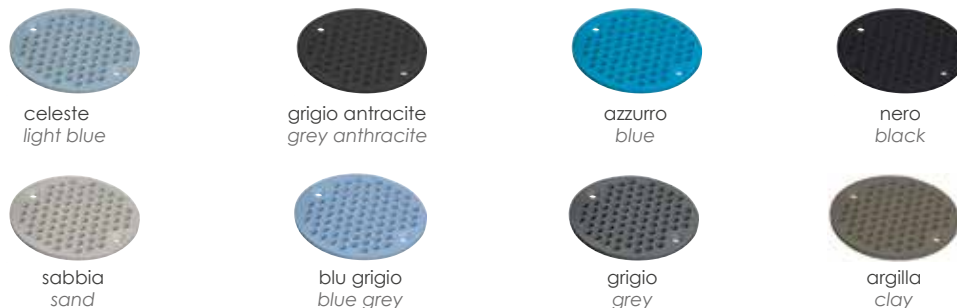

**Flangia, griglia e guarnizioni per bocchetta C-319- colorato / flange, gratings and gaskets for jet C-319 colored**

Codice/ code	1072260	1072261	1072263	1072264	1072265	1072266	1072267	1072269
Colore/Color	celeste/light blue	azzurro/blue	sabbia/sable	grigio/gray	antracite/anthracite	nero/black	b. grigio/b. gray	argilla/clay

**PASSANTI A MURO IN ABS / THROUGHWALL FLANGE IN ABS**



cod.1070060



cod.1070061

Codice / code	Descrizione /description
1070060	Passante a muro da 250 mm, filettato 2" e 50 a incollaggio / throughwall flange 250 mm, thread 2" and bonding 50
1070061	Passante a muro universale da 250 mm / universal throughwall flange 250 mm



## BOCCHETTE DI MANDATA ED ASPIRAZIONE / RETURN FITTING IN ABS FOR LINER

Regolazione del getto orientabile semplificato ed ultra-rapido. Nessun pezzo in sporgenza, compreso il getto orientabile (estetica e comfort d'utilizzo). Viti di fissaggio della flangia completamente mascherate dalla cornice del getto orientabile. 4 inserti di chiusura supplementari compresi (oltre ai 4 forniti per l'installazione) molto utili in caso di eventuale sostituzione o smontaggio della flangia. Due possibilità di raccordo per lo stesso pezzo Ø50 ad incollaggio (femmina) e 2" filettato (maschio).

The regulation of the adjustable jet is simplified and fast. No protruding pieces, including the adjustable jet (aesthetics and ease of use). Holding screws of the flange completely masked by the adjustable jet. 4 additional closure inserts including (in addition to the 4 supplied for installation) are very useful in case of replacement or dismantling of the flange. Two possibilities for the same piece: bonding fitting Ø50 (female) and 2" thread (male).



cod.1070067



cod.1070168



cod.1070073



cod.1070071



cod.1070072



cod.1071172



cod.1070252

Codice / code	Descrizione /description
1070067	Bocchetta liner filettata 2" Ø 50 a incollaggio con getto orientabile / Bonding return fitting for liner with orientable jet
1070168	Bocchetta con inserti in ottone, per pannello/liner, con dado / Return fitting with insert and jet, for panel/liner, with nut
1070073	Bocchetta con getto orientabile per piscina a parete sottile, dado di serraggio e flangia / Return fitting with orientable jet for pool with thin wall, tightening nut and flange
1070071	Bocchetta con griglia aspirazione/mandata 2" Ø 63 a incollaggio, liner / Bonding return fitting with aspiration/expiration grid
1070072	Bocchetta con griglia aspirazione/mandata 3" Ø 90 a incollaggio, liner / Bonding return fitting with aspiration/expiration grid
1070252	Bocchetta con griglia aspirazione 2"½/63, griglia 162 mm, liner / Return fitting with aspiration grid 2"½/63, grid 162 mm, liner
1071172	Bocchetta con griglia aspirazione per fondo e pareti 3" Ø 90 a incollaggio, liner / Bonding return fitting with aspiration/expiration grid

## ACCESSORI BOCCHETTE RETURN FITTING ACCESSORIES



cod.1070090



cod.1070091



cod.1070092



cod.1070093

Codice /code	Descrizione /description
1070090	Getto orientabile Ø 23 mm per bocchette / orientable jet for return fitting
1070091	Tappo filettato 1"½ con guarnizione torica / threaded cap with gasket
1070092	Tappo filettato per bocchette, bianco / white threaded cap for return fitting
1070093	Portagomma presa spazzola avvitato con filetto Ø 38 x 1"½ / swivelling barbed end-piece

PROIETTORI FISSI / FIXED UNDERWATER LIGHT



Guarnizione adesiva protezione per cantiere; bloccaggio della lampada a baionetta, la lampada non esce dal suo alloggiamento; facile smontaggio; cavo specifico subacqueo lungo 2,20 m, che permette un cambio facilitato della lampada; uscita del cavo di alimentazione superiore, cavo semi-rigido regolabile e pressacavo di sicurezza; possibilità di fissaggio su parete prefabbricata; sistema auto-bloccante di chiusura del coperchio con guarnizione OR per maggiore tenuta e sicurezza; consegnate con pressacavo a tenuta rapida.

*Adhesive gasket for protection site; lock of the lamp; easy removal of the lamp; specific underwater cable m 2.20, which allows a facilitated exchange of the lamp; output of the power cord, rigid adjustable cable and safety cord-locks; possibility of fixing on prefabricated wall; self-locking system closure of the cover with O-ring seal for greater and security, delivered with rapid-tight cord-lock.*

Codice /code	Descrizione /description
	PROIETTORE FISSO IN ABS A LED PER LINER / FIXED LED UNDERWATER LIGHT IN ABS FOR LINER
1070224	Proiettore liner a 60 LED colore bianco 13,5W 12V ac, fissaggio a vite con inserti in ottone White led for liner, fixed with screw, with brass inserts
1070225	Proiettore liner a 90 LED RGB 16W 12V ac con telecomando, fissaggio a vite con inserti in ottone RGB led for liner, fixed with screw, with remote control, with brass inserts

PROIETTORI FISSI / FIXED UNDERWATER LIGHT



sabbia sand



grigio grey



grigio antracite grey anthracite



azzurro blue



celeste light blue

Proiettore per liner LED colore bianco 13,5 W - 12 V ac, fissaggio a vite-colorato / white underwater light for liner with screw

Codice/code	1072178	1072175	1072177	1072174	1072172
Colore/color	sabbia/sable	grigio/gray	antracite/anthracite	celeste/light blue	azzurro/blue

Proiettore per liner LED RGB 16W - 12V ac con telecomando, fissaggio a vite-colorato / RGB underwater light for liner with screw

Codice/code	1072036	1072046	1072116	1072006	1072016
Colore/color	sabbia/sable	grigio/gray	antracite/anthracite	celeste/light blue	azzurro/blue

SCATOLE DI DERIVAZIONE UNIVERSALI / UNIVERSAL DECK BOXES



- Dimensioni 11,5x11,5 cm
- Colori bianco, sabbia o grigio
- Montaggio in serie o parallelo, tenuta perfetta e regolazione della lunghezza del cavo
- *Dimensions 11,5x11,5 cm*
- *White, sand or grey colors*
- *Mounting in series or parallel, perfect fit and adjustment of cable length*

Codice /code	Descrizione /description
1070048	Scatole di derivazione universale 2 uscite e 1 entrata / Universal deck boxes 2 outputs and 1 input
1070049	Scatole di derivazione universale color sabbia, 2 uscite e 1 entrata / Sand universal deck boxes 2 outputs and 1 input
1070050	Scatole di derivazione universale color grigio, 2 uscite e 1 entrata / Grey universal deck boxes 2 outputs and 1 input

**MINI PROIETTORE SERIE MT-4 DA AVVITARE SU UNA BOCCHETTA  
MINI UNDERWATER LIGHT MT-4 TO SCREW IN A RETURN FITTING**



**Installazione con prodotto  
cod.1070065**  
To be installed with product  
code 1070065

Proiettore a led piatto da avvitare su passante da 1"½; ripartizione della luce omogenea, armoniosa, non accecante; corpo lampada realizzato per iniezione di policarbonato ed ABS che gli conferisce un'elevata resistenza a shock, calore ed aggressioni chimiche dei prodotti per il trattamento dell'acqua; alimentazione 12V ac 50~60 Hz da fornirsi mediante trasformatore toroidale protetto; cablaggio 2x1,5mm, fornito senza cavo; possibilità di sincronizzazione per sistemi a più lampade; realizzazione di impianti multi proiettore con centralina di controllo remoto a 1 o 4 canali; è necessario prevedere un passante da 1"½.

*Flat led underwater light screwed on to in a 1"½ return fitting; distribution of homogeneous light, harmonious and not blinding for the swimmers; body-lamp made for injection of polycarbonate and ABS, which ensures high resistance to shock, heat and chemical attack of water treatment products; 12V ac 50 ~ 60 Hz to be provided by a toroidal protected transformer; wiring 2x1, 5 mm, supplied without cable; synchronization capabilities for multi-lamp systems, construction of multi-projector systems with control remote control to 1 or 4 channels; it is necessary to provide a return fitting 1"½.*

**VERSIONI DISPONIBILI / VERSIONS AVAILABLE**

- Lampada led universale monocromatica colore bianco (7000/8000°K) con funzionamento ON/OFF
- Lampada led universale multicolore RGB con funzionamento ON/OFF
- 11 Colori fissi e 5 programmi automatici
- Universal Monochrome LED lamp in white (7000/8000 ° K) with ON/OFF
- Universal LED multicolour RGB lamp with ON/OFF
- 11 fixed colors and 5 automatic programs

Codice /code	Descrizione /description
1070171	Mini proiettore a led RGB 36 LED 6,8 W - 12 V ac / mini RGB led underwater light 36 LED 6,8 W - 12 V ac
1070172	Mini proiettore a led bianco 12 LED 4,0 W - 12 V ac / mini white led underwater light 12 LED 4,0 W - 12 V ac

**PROIETTORE PIATTO SERIE MT-4 DA AVVITARE SU UNA BOCCHETTA  
FLAT UNDERWATER LIGHT MT-4 TO BE SCREWED ON A RETURN FITTING**

**Nuovo Design**



**Installazione con prodotto  
cod.1070065**  
Installing with product  
cod.1070065

Corpo proiettore realizzato in policarbonato ed ABS con elevata resistenza a shock, calore ed aggressioni chimiche dei prodotti per il trattamento dell'acqua; alimentazione 12V ac 50~60 Hz da fornirsi mediante trasformatore toroidale protetto; cablaggio 2x1,5 mm, fornito senza cavo; possibilità di sincronizzazione per sistemi a più lampade; realizzazione di impianti multi proiettore con centralina di controllo remoto a 1 o 4 canali; dimensioni: Ø 290 mm, L 60 mm.

*Projector-body made of polycarbonate and ABS with high resistance to shock, heat and chemical attack of water treatment products; 12V ac 50 ~ 60 Hz to be provided by a toroidal transformer protected; wiring 2x1,5 mm, supplied without cable; synchronization capabilities for multi-lamp systems, construction of multi-projector systems with remote control with 1 or 4 channels; dimensions: Ø 290 mm, L 60 mm.*

**VERSIONI DISPONIBILI**

- Led universale monocromatico colore bianco (6500°K) con funzionamento ON/OFF
- Led universale multicolore RGB con funzionamento ON/OFF e switching a pulsante o telecomando in dotazione
- 11 colori fissi e 5 programmi automatici

**AVAILABLE VERSIONS**

- Universal led underwater light, color white (6500°K) with ON/OFF.
- Universal projector multicolor RGB LED with ON / OFF switching button or remote control.
- 11 fixed colors and 5 automatic programs

Codice /code	Descrizione /description
1070166	Proiettore piatto 90 LED RGB 16,0W-12 V ac con telecomando / Flat underwater light 90 RGB LED 16,0 W - 12 V ac with rc
1070169	Proiettore piatto 60 LED bianco 13,5 W - 12 V ac / Flat underwater light 60 white LED 16,3 W - 12 V ac
ACCESSORI / accessories	
1070229	Corona cromata satinata / mat metal crown
1070228	Corona grigio antracite / anthracite grey crown
1070211	Corona grigio chiaro / light grey crown
1070227	Corona celeste / light blue crown
1070226	Corona sabbia / sand crown



Cod.  
1070229



Cod.  
1070227



Cod.  
1070228



Cod.  
1070226



Cod.  
1070211

**ACCESSORI INSTALLAZIONE PER MINI PROIETTORE E PROIETTORE PIATTO - SERIE MT-4**  
**INSTALLATION ACCESSORIES FOR MINI AND FLAT UNDERWATER LIGHTS - SERIE MT-4**

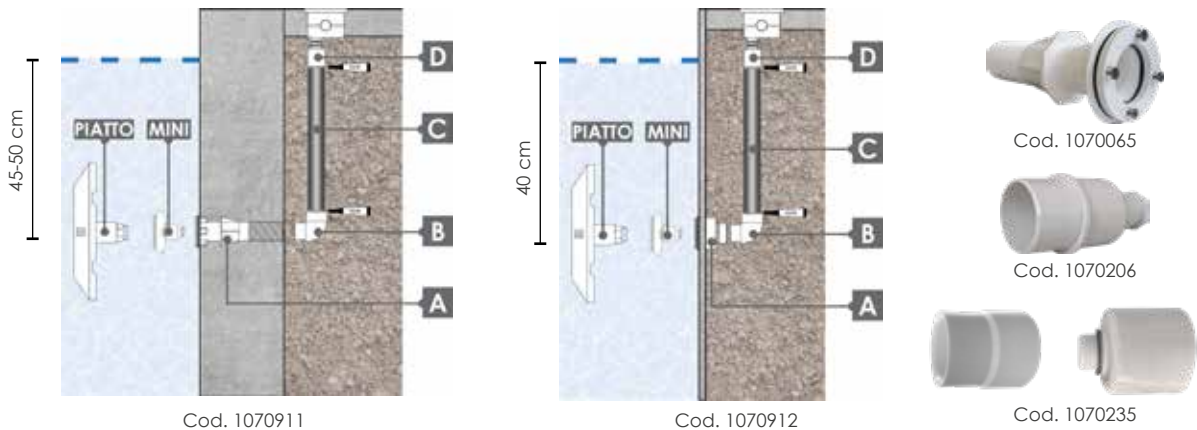

Codice /code	Descrizione /description
1070911	Kit installazione proiettore piatto e mini per c.a./liner / Mini and flat underwater light installation kit - c.a./ liner
1070912	Kit installazione proiettore piatto e mini per pannelli / Mini and flat underwater light installation kit - panels
RICAMBIO / replacement	
1070235	Kit adattatore proiettore piatto / Flat underwater light adapter kit
1070065	Passante a parete per proiettore per liner / Liner throughwall with flange for underwater light
1070206	Chiusura maschio con pressacavo Ø 50mm / Cap with cable gland Ø50mm

**LAMPADA LED PER FARO UNIVERSALE SERIE MT-4 / LED LAMP FOR UNDERWATER LIGHT MT-4**



Corpo lampada realizzato in policarbonato con elevata resistenza a shock, calore ed aggressioni chimiche dei prodotti per il trattamento dell'acqua. Terminali di cablaggio a vite completamente annegati nel corpo lampada per una tenuta migliore. Alimentazione 12V ac 50-60 Hz da fornirsi mediante trasformatore toroidale protetto. Cablaggio 2x1,5 mm<sup>2</sup>. Possibilità di sincronizzazione per sistemi a più lampade. Realizzazione di impianti multi proiettore con centralina di controllo remoto a 1 o 4 canali. Dimensioni: Ø 178 mm, L 90 mm.

Lamp housing made of polycarbonate with high resistance to shock, heat and chemical attack of water treatment products. Screwed terminal wiring, completely drowned in the lamp body for a better seal. 12V ac 50 ~ 60 Hz to be provided by a toroidal protected transformer. Wiring 2x1,5 mm<sup>2</sup>. Possibility of synchronization for systems with lights. Realization of plant with multi-projector with remote control unit 1 or 4 channels. Dimensions: Ø 178 mm, L 90 mm.

**VERSIONI DISPONIBILI**

LED monocromatico colore bianco (6500°K) con funzionamento ON/OFF.

- LED multicolore RGB con funzionamento ON/OFF e switching a pulsante o telecomando in dotazione.
- 11 Colori fissi e 5 programmi automatici.

**VERSIONS AVAILABLE**

Universal led lamp, color white (6500°K) with ON/OFF.

- Universal lamp multicolor RGB LED with ON / OFF switching button or remote control.
- 11 fixed colors and 5 automatic programs



Codice /code	Descrizione /description
LAMPADE CON CONNETTORE STAGNO / LAMP WITH WATERTIGHT CONNECTOR	

1070165	Lampada per faro PAR56 90 LED RGB 16W 12V ac con telecomando Lamp for underwater light PAR56 90 RGB LED 16W 12V ac with rc
1070152	Lampada per faro PAR56 60 LED colore bianco 13,5W 12V ac Lamp for underwater light PAR56 60 white LED 13,5W 12V ac

**LAMPADE CLASSICHE / CLASSIC LAMP**

1070157	Lampada per faro PAR56 90 LED RGB 16W 12V ac con telecomando Lamp for underwater light PAR56 90 RGB LED 16W 12V w/remote control	
1070802	Lampada per faro PAR56 90 LED RGB 16W 12V ac con telecomando Lamp for underwater light PAR56 90 RGB LED 16W 12V w/remote control	12 pz 12 pcs
1070156	Lampada per faro PAR56 60 LED colore bianco 13,5W 12V ac Lamp for underwater light PAR56 60 white LED 13,5 W 12V ac	
1070803	Lampada per faro PAR56 60 LED colore bianco 13,5W 12V ac Lamp for underwater light PAR56 60 white LED 13,5 W 12V ac	12 pz 12 pcs

**ACCESSORI / ACCESSORIES**

1070809	Kit di installazione universale bianco / white universal installation kit
1070916	Kit di installazione universale grigio / grey universal installation kit
1070917	Kit di installazione universale sabbia / sand universal installation kit
1070918	Kit di installazione universale antracite / anthracite universal installation kit
1070920	Kit di installazione universale celeste / light blue universal installation kit

**RICAMBIO LAMPADE UNIVERSALI PAR56 e PROIETTORI PIATTI RGB serie MT-4**

1070194	Telecomando radio 4 pulsanti - dal 2020
1070185	Telecomando radio 4 pulsanti - fino al 2019 (fino ad esaurimento scorte) Radio remote control 4 buttons



Kit installazione universale  
Universal installation kit



cod.1070194 cod.1070185

PROIETTORI MICRO SERIE MT-4 / MICRO PROJECTORS MT-4



Cod. 1070184 - 1070170



Corpo proiettore realizzato in policarbonato da avvitare su passante da 1"½, cablaggio 2x1mm, alimentazione 12V ac 50~60 Hz, possibilità di sincronizzazione per sistemi a più lampade; dimensioni: Ø 49mm, L 102 mm.

Projector-body made of polycarbonate screwed on to in a 1"½ return fitting, wiring 2x1 mm, 12V ac 50 ~ 60 Hz power supply, synchronization capabilities for multi-lamp systems; dimensions: Ø 49 mm , L 102 mm

VERSIONI DISPONIBILI

- Lampada led universale monocromatica colore bianco (6500°K) con funzionamento ON/OFF
- Lampada led universale multicolore RGB con funzionamento ON/OFF
- 11 Colori fissi e 5 programmi automatici

VERSIONS AVAILABLE

- Universal Monochrome LED lamp in white (6500°K) with ON/OFF
- Universal LED multicolour RGB lamp with ON/OFF
- 11 fixed colors and 5 automatic programs

Codice /code	Descrizione /description
1070184	Proiettore micro a 9 led RGB 8,2 W - 12 V ac / micro 9 RGB led projector 8,2 W - 12 V ac
1070170	Proiettore micro a 18 led bianco 6,0 W - 12 V ac / micro white 18 led projector 6,0 W - 12 V ac

ACCESSORI / accessories

Corona di finitura a fissaggio rapido rotonde



Codice /code	1070255	1070256	1070257	1070259	1070260
Colore/color	bianco white	grigio chiaro light grey	grigio scuro medium grey	sabbia sand	azzurro light blue



Corona di finitura a fissaggio rapido quadrate



Codice /code	1070261	1070262	1070263	1070265	1070266
Colore/color	bianco white	grigio chiaro light grey	grigio scuro medium grey	sabbia sand	azzurro light blue



Corona di finitura a fissaggio rapido metallizzata



Codice /code	1070258	1070264
Colore/color	metallizzato metalized	metallizzato metalized



ACCESSORI INSTALLAZIONE PER PROIETTORE MICRO - SERIE MT-4  
INSTALLATION ACCESSORIES FOR MICRO PROJECTOR - SERIE MT-4

Codice /code	Descrizione /description
1070913	Kit installazione proiettore micro per c.a./linerMicro projector installation kit - c.a./ liner
1070914	Kit installazione proiettore micro per pannelli / Micro projector installation kit - panels

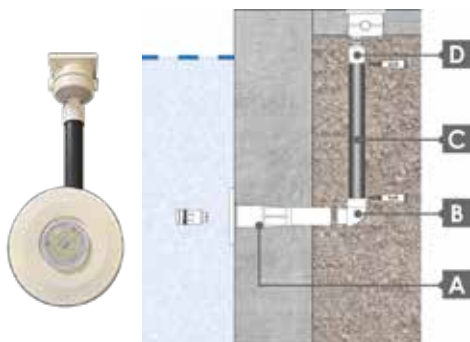

Cod. 1070913

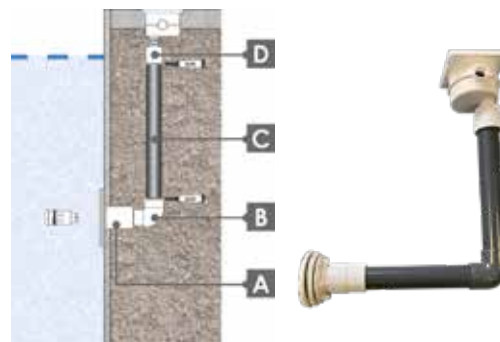

Cod. 1070914



## SCATOLA DI COMANDO RADIO / RADIO CONTROL BOX



Disponibile nella versione 1 o 4 canali, è il complemento ideale per un impianto d'illuminazione per piscine. Può controllare una lampada o gestire un impianto di illuminazione globale. Permette di collegare fino a 12 proiettori senza modifiche dell'impianto elettrico. Il sistema radio garantisce un'ottima portata del telecomando. Elettronica installata in una scatola in ABS rafforzata a tenuta stagna per un impiego esterno (IP65). Si possono sincronizzare tutti i proiettori (modello 1 canale) o creare ambienti colorati diversi nella stessa piscina (modello 4 canali). Si installa senza lavori specifici sull'alimentazione elettrica 12Vac dei proiettori. Ogni scatola è fornita di connettori per cavo di sezione fino a 4 mm.

Available in 1 or 4 channels, it is the ideal complement for a lighting system for pools. It can control a lamp or manage a global illumination system. It allows you to connect up to 12 projectors without major modification. The radio system provides an excellent range of the remote. Electronics installed in a box in ABS reinforced watertight for outdoor use (IP65). You can sync all projectors (model 1 channel) or create different colored in the pool (model 4 channels). It installs without any specific work on the power supply 12Vac of the projectors. Each box is provided with connectors for wire section up to 4 mm.

Codice /code	Descrizione /description
1070192	Scatola di comando radio 1 canale - fino a 12 proiettori - 12V ac radio control box 1 channel - up to 12 lights
1070193	Scatola di comando radio 4 canali - fino a 27 proiettori - 12V ac radio control box 4 channels - up to 27 lights
RICAMBIO / replacement	
1070196	Telecomando 2 pulsanti per sc. comando radio 1 canale 1070192 2 buttons remote control for control box 1 channel
1070197	Telecomando 8 pulsanti per sc. comando radio 4 canali 1070193 8 buttons remote control for control box 4 channels
1070187	Telecomando 2 pulsanti per sc. comando radio 1 canale fino al 2019 (fino ad esaurimento scorte) 2 buttons remote control for control box 1 channel
1070188	Telecomando 8 pulsanti per sc. comando radio 4 canali fino al 2019 (fino ad esaurimento scorte) 8 buttons remote control for control box 4 channels
ACCESSORI / accessories	
1070204	Kit antenna per scatola di comando radio 1 e 4 canali con cavo di 3 metri e kit di fissaggio Kit antenna for radio control box 1 and 4 channels with cable 3 meters and fixing kit

## PROIETTORE A LED INOX SERIE MT-4 / STAINLESS STEEL LED LIGHT MT-4



Per l'illuminazione continua e armoniosa dell'ambiente attorno alla piscina. Può essere installato anche immerso per illuminare una fontana o una vasca ornamentale. Realizzato in acciaio inox, eccellente resistenza alla corrosione sia all'esterno che sott'acqua. Alimentazione 12V ac 50~60 Hz da fornirsi mediante trasformatore toroidale protetto. Cablaggio 2x1,5 mm<sup>2</sup>. Possibilità di sincronizzazione per sistemi a più lampade. Realizzazione di impianti multi proiettore con centralina di controllo remoto a 1 o 4 canali. Dimensioni: Ø 143 mm

For the continuous light and harmonious of the environment around the pool. It can also be installed under the water to illuminate a fountain or a ornamental pool. Made of inox steel, excellent corrosion resistance outside and under water. 12V ac 50 ~ 60 Hz to be provided by a toroidal protected transformer.

Wiring 2x1,5 mm<sup>2</sup>. Possibility of synchronization for systems with lights. Realization plant with multi projectors with remote control unit 1 or 4 channels. Dimensions: Ø 143 mm

### VERSIONI DISPONIBILI

- Lampada led universale monocromatica di colore bianco (7000/8000°K) con funzionamento ON/OFF.
- Lampada led universale multicolore RGB con funzionamento ON/OFF.
- 11 Colori fissi e 5 programmi automatici.

### VERSIONS AVAILABLE

- Universal led lamp, color white (7000/8000°K) with ON/OFF.
- Universal led lamp, color RGB with ON/OFF.
- 11 fixed colors and 5 automatic programs.

Codice /code	Descrizione /description
1070315	Proiettore a Led INOX 316 36 LED RGB 35,8 W - 12 V ac / LED stainless steel 316 light 36 LED RGB 35,8 W - 12 V ac
1070316	Proiettore a Led INOX 316 30 LED bianco 14,7 W - 12 V ac / LED stainless steel 316 light 30 LED white 14,7 W - 12 V ac
1070311	Proiettore a Led INOX 316 36 LED RGB 7,2 W - 12 V ac / LED stainless steel 316 light 36 LED RGB 7,2 W - 12 V ac

LAMPADA RICARICABILE, IMPERMEABILE E MOBILE / LAMP RECHARGEABLE, WATERPROOF AND MOBILE



100% impermeabile e mobile, la lampada ricaricabile è perfetta sia in giardino che in piscina. Dimensioni 115 mm. Vantaggi:

- MOBILE, grazie alla sua base magnetica, è possibile fissarla ovunque, anche sott'acqua.
- FACILE DA UTILIZZARE, grazie a una semplice pressione sul tasto centrale dell'ottica è possibile accendere, spegnere e cambiare colori.
- PERFORMANTE, è disponibile in versione luce bianca RGB con 7 colori e 3 programmi.

100% waterproof and mobile, it makes ovunque light you need: in the garden, at home, in the pool. Dimensions 115 mm.

- MOBILE, thanks to its magnetic base, it secured everywhere, even under water
- EASY TO USE, by simply pressing the central button of optics you can turn on, turn off and change colors.
- PERFORMING, it's available in white light version or RGB version with 7 colors and 3 programs.

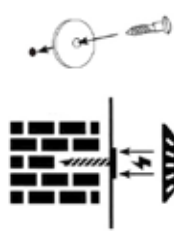

bianco  
white  
cod.1070806



azzurro  
light blue  
cod.1070807



grigio  
grey  
cod.1070808



blu  
blue  
cod.1070801

Codice /code	Descrizione /description
1070805	Lampada ricaricabile, impermeabile e mobile, 18 LED bianco Rechargeable, waterproof and mobile white 18 LED
1070806	Lampada ricaricabile, impermeabile e mobile, RGB, 18 LED, corona bianca Rechargeable, waterproof and mobile, lamp RGB, 18 LED, white crown
1070807	Lampada ricaricabile, impermeabile e mobile, RGB, 18 LED, corona azzurra Rechargeable, waterproof and mobile, lamp RGB, 18 LED, light blue crown
1070808	Lampada ricaricabile, impermeabile e mobile, RGB, 18 LED, corona grigia Rechargeable, waterproof and mobile, lamp RGB, 18 LED, grey crown
1070801	Lampada ricaricabile, impermeabile e mobile, RGB, 18 LED, corona blu Rechargeable, waterproof and mobile, lamp RGB, 18 LED, dark blue crown

PROIETTORE A LED EXTRA PIATTO / EXTRA FLAT LED UNDERWATER LIGHT

SERIE MT-4



Concepito per un'installazione senza lavori o attrezzatura specifica, il proiettore si posiziona in qualsiasi tipo di piscina a parete rigida che possieda almeno una bocchetta di mandata filettata femmina 1" 1/2. Realizzato per iniezione di policarbonato ed ABS, gli conferisce un'alta resistenza agli shock, al calore ed alle aggressioni chimiche dei prodotti per il trattamento dell'acqua. Pronto per l'utilizzo, è fornito in kit valigia con: un cavo da 6 metri, un trasformatore 230V/12V ac (tipo presa di corrente), un telecomando radiofonico ed una bocchetta d'immissione filettata all'interno femmina 1"1/2.

*Designed to installation without specific equipment, the underwater light is placed in any type of pool that has a rigid wall with a return fitting with female threaded 1 "1/2. Realized by injection of polycarbonate and ABS which gives it a high shock resistance, heat and chemical attack of the products for water treatment. Ready to use, it is in a kit bag with: a 6 meter cable, a transformer type 230V/12V ac outlet, a radio remote control and an return fitting with female threaded 1 "1/2.*

Codice /code	Descrizione /description
PROIETTORE A LED PER PISCINE FUORI TERRA / LED FOR ABOVE GROUND POOLS	
1070205	Proiettore 18 LED bianco 9,7 W - 12 V ac / white light
1070125	Proiettore 36 LED RGB 7,8 W - 12 V ac con telecomando / RGB light with remote control
1070189	Trasformatore 230V/12V ac / transformer type
RICAMBIO / replacement	
1070186	Telecomando radio 4 pulsanti / radio remote control with 4 buttons



**SKIMMER SERIE MT-3 IN ABS PER LINER E PER PISCINE IN CEMENTO**  
**SKIMMER MT-3 IN ABS FOR LINER AND FOR CONCRETE POOLS**

Skimmer filettati 1"½ interno, 2" esterno. Completi di flangia, guarnizioni e viti inox per tenuta della membrana di impermeabilizzazione per piscine cemento/liner

Skimmer with interior thread 1" ½, outside 2". Complete with flanges, gaskets and screws for tightness of the waterproofing membrane for cement / liners pools

SKIMMER A BOCCA SVASATA CON PROLUNGA / WIDE MOUTH SKIMMER WITH EXTENSION

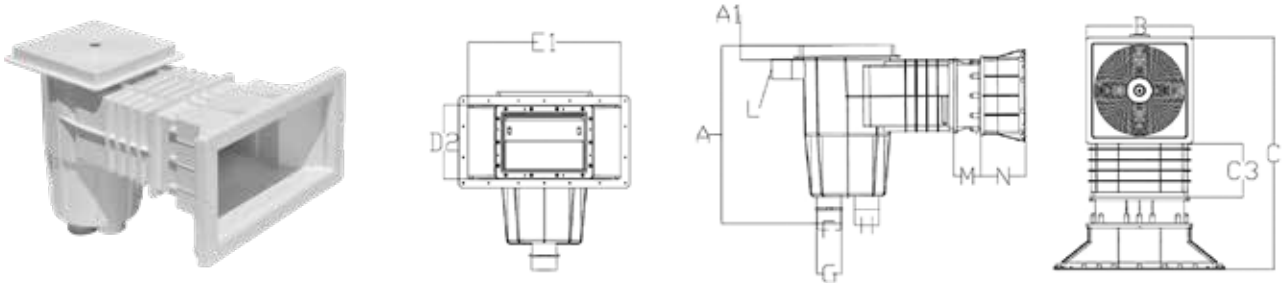

DIMENSIONI / DIMENSIONS

A mm	A1 mm	B mm	C mm	C3 mm	D2 mm	E1 mm	F mm	G mm	H mm	L mm	M mm	N mm
416	25,31	248,90	565	137	172,50	358	50 (1"½)	63 (2")	63 (2")	46	73	105

Codice /code	Descrizione /description
2220109	Skimmer a bocca svasata con inserti in ottone e prolunga per muri di cemento armato rif.96511V wide mouth skimmer with brass inserts and extension for concrete walls
2220300	Skimmer a bocca svasata con inserti in ottone e prolunga + guarnizione sandwich piscine in pannelli wide mouth skimmer w/brass inserts and extension+seal sandwich
2220139	Kit flangia+guarnizioni+viti skimmer 96511V-96501V / kit with flange,seal and screws for skimmer
2220200	Guarnizione sandwich / sandwich seal

SKIMMER A BOCCA STANDARD / STANDARD MOUTH SKIMMER

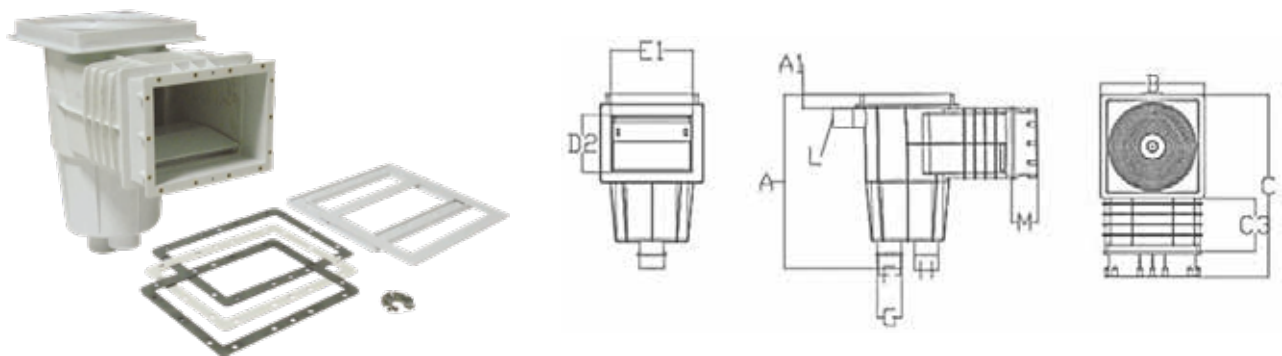

DIMENSIONI / DIMENSIONS

A mm	A1 mm	B mm	C mm	C3 mm	D2 mm	E1 mm	F mm	G mm	H mm	L mm	M mm
416	25,31	248,90	450,00	137,00	136,00	196	50 (1"½)	63 (2")	63 (2")	46	73

Codice /code	Descrizione /description
2220133	Skimmer a bocca standard con inserti in ottone standard mouth skimmer with brass inserts
2220145	Skimmer a bocca standard senza inserti in ottone standard mouth skimmer without brass inserts

## SKIMMER A BOCCA STRETTA / SMALL MOUTH SKIMMER

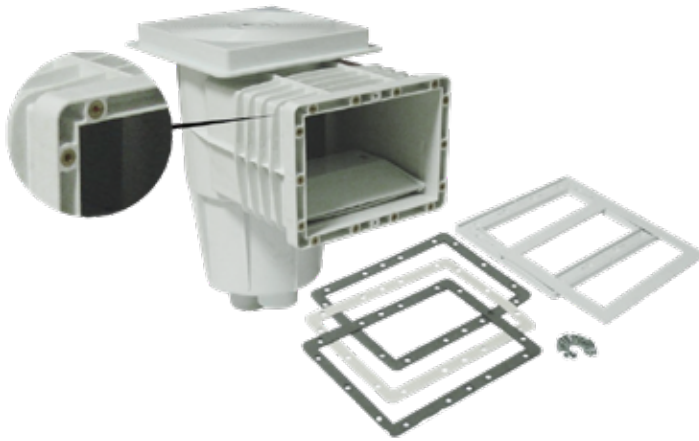

## DIMENSIONI / DIMENSIONS

A mm	A1 mm	B mm	C mm	C3 mm	D2 mm	E1 mm	F mm	G mm	H mm	L mm
416	25,31	248,90	400,00	137,00	136,00	139,70	50 (1 1/2)	63 (2")	63 (2")	46

Codice /code	Descrizione /description
2220146	Skimmer a bocca stretta con inserti in ottone small mouth skimmer with brass inserts

## SIRINGA CON ABS LIQUIDO PER LE RIPARAZIONI / SYRINGE IN ABS LIQUID FOR THE REPAIRS

**SIRINGA ABS**

Liquido per la riparazione di tutti i pezzi in ABS  
ABS syringe of liquid for the repair of all parts in ABS

Codice /code	Descrizione /description
1070023	Siringa con ABS liquido per la riparazione di tutti i pezzi in ABS ABS syringe of liquid for the repair of all parts in ABS

**BOCCHETTE DA FONDO SERIE MT-3 / BOTTOM INLET MT-3**



cod. 2220106

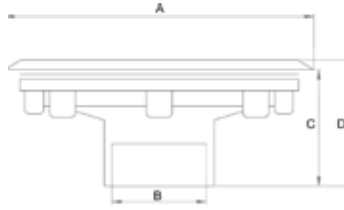

**DIMENSIONI / DIMENSIONS**

A mm	B mm	C mm	D mm
164,6	50	59,8	66,6



cod. 2220132



**DIMENSIONI / DIMENSIONS**

A mm	B mm	C mm	D mm	E mm	F mm
108	60	50	73,12	67,10	6,02

Codice /code	Descrizione /description
2220106	Bocchetta a pavimento filettata bianca diam. interno 50, esterno 2", con flangia, guarnizioni e viti inox per tenuta della membrana di impermeabilizzazione per piscine cemento/liner/ floor inlet threaded internal diam.50, external 2" with flange, gaskets and screws for waterproofing membrane for pool cement/liner
2220132	Bocchetta a pavimento bianca diam. interno 50 a incollaggio per piscine cemento/ Floor inlet internal diameter Ø 50 for pool cement/liner



grigio  
grey



azzurro  
blue



celeste  
light blue



grigio antracite  
grey anthracite



sabbia  
sand

**Bocchetta a pavimento filettata colorata/ floor inlet threaded internal**

Codice/code	2220160	2220161	2220162	2220163	2220164
Colore/color	grigio/gray	antracite/ anthracite	celeste/light blue	azzurro/blue	sabbia/sand

**PRESA SPAZZOLA SERIE MT-3 / VACUUM POINT MT-3**



cod. 2220126

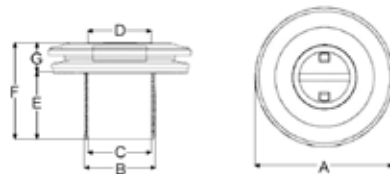

**DIMENSIONI / DIMENSIONS**

A mm	B mm	C mm	D mm	E mm	F mm	G mm
118,9	2"	50	53,9	55	78	23



cod. 2220105

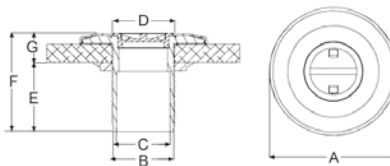

**DIMENSIONI / DIMENSIONS**

A mm	B mm	C mm	D mm	E mm	F mm	G mm
118,9	2"	50	53,9	55	66,55	9,90

Codice /code	Descrizione /description
2220126	Presa a spazzola a parete filettata 2" esterno, Ø50 interno a incollaggio, con flangia, guarnizioni e viti inox per tenuta della membrana di impermeabilizzazione per piscine cemento/liner vacuum point to wall threaded external 2" - bonding internal Ø 50 with flange, gaskets and screws for waterproofing membrane for pool cement/liner
2220105	Presa a spazzola a parete filettata 2" esterno, Ø50 interno a incollaggio con anello di serraggio e guarnizioni per piscine in vetroresina/vacuum point to wall threaded external 2" - bonding internal Ø 50 with with clamping ring and gaskets for vtr pools

## BOCCHETTE DI IMMISSIONE SERIE MT-3 / RETURN FITTINGS MT-3



cod. 2220100



cod. 2220101

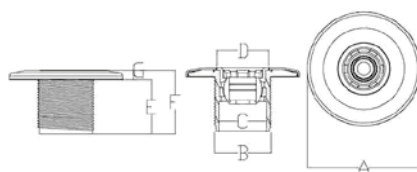

## DIMENSIONI / DIMENSIONS

A mm	B mm	C mm	D mm
118,9	2"	50	53,9
E mm	F mm	G mm	
56,65	66,75	9,90	



cod. 2220102

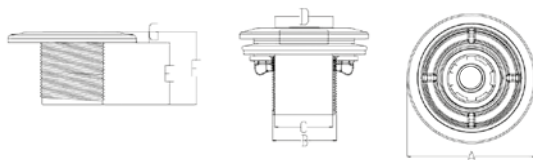

## DIMENSIONI / DIMENSIONS

A mm	B mm	C mm	D mm
118,9	2"	50	53,9
E mm	F mm	G mm	
56,65	66,75	9,90	

Codice / code	Descrizione /description
2220100	Bocchetta di immissione a parete filettata 2" esterno - diam.50 interno a incollaggio per piscine cemento Return fitting to wall threaded external 2" - bonding internal Ø 50 for cement pool
2220101	Bocchetta di immissione a parete filettata 2" esterno - diam.50 interno a incollaggio - con anello di serraggio e guarnizioni per piscine in vetroresina - senza flangia di tenuta/ Return fitting to wall threaded external 2" - bonding internal Ø 50 with clamping ring and gasket for pool with thin wall - without air-tight flange
2220102	Bocchetta di immissione a parete filettata 2" esterno - diam.50 interno a incollaggio - con anello di serraggio, flangia, guarnizioni e viti inox per tenuta della membrana di impermeabilizzazione per piscine cemento/liner/parete sottile ugello diam.20 mm / Return fitting to wall threaded external 2" - bonding internal Ø 50 with flange, gasket and screws for waterproofing membrane for pool cement/liner- nozzle Ø 50

## POZZETTI DI FONDO SERIE MT-3 / MAIN DRAIN MT-3



Codice / code	Descrizione /description
2220108	Pozzetto di fondo In ABS - diam. 170mm - uscita laterale filetto 2" con flangia, guarnizioni e viti inox per tenuta della membrana di impermeabilizzazione per piscine cemento/liner main drain in ABS Ø 170 mm- side exit threaded 2" with flange, gaskets and screws for waterproofing membrane for pool cement/liner
2220128	Kit flangia+guarnizioni+viti pozzetto di fondo 96467V-96467C /kit with flange, seal and screws for main drain

## DIMENSIONI / DIMENSIONS

Codice	A mm	B mm	C mm	D mm	E mm
2220108	167	229,5	118,95	63(2")	45

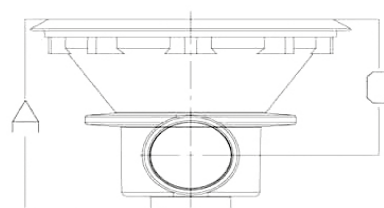
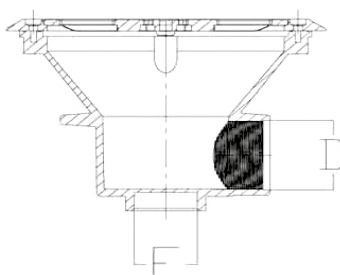
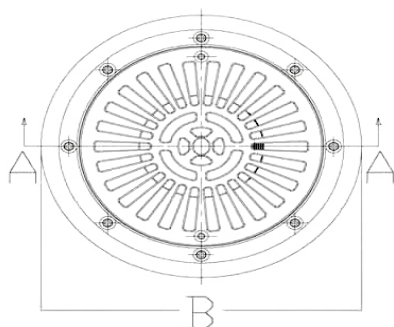

**PROIETTORI SERIE MT-3  
UNDERWATER LIGHT MT-3**

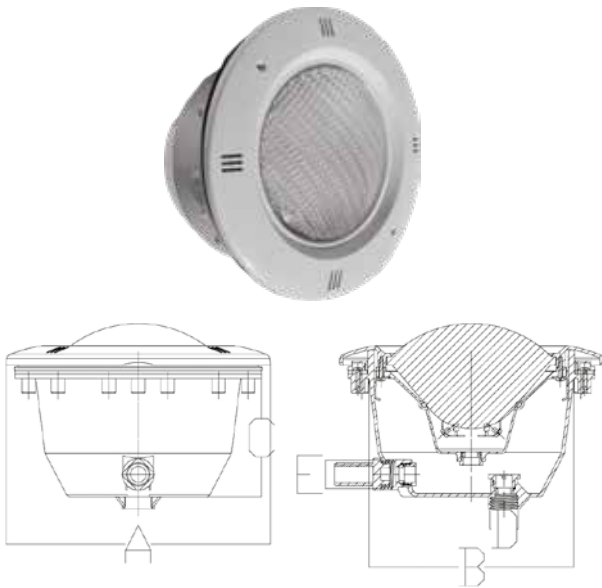

- Proiettori di illuminazione subacquea per piscine interrate 300 Watt, 12 V
- Completi di cassa di alloggiamento, corpo lampada, flangia, guarnizioni e viti inox per tenuta della membrana di impermeabilizzazione per piscine cemento/liner. Inserti in ottone.
- Underwater light for inground pools 300 Watt/12 V
- Complete with housing box, lamp-body, flange gaskets and screws for tightness of the waterproofing membrane for cement/liners pools. Brass Inserts.

**DIMENSIONI / DIMENSIONS**

A mm	B mm	C mm	D mm	E mm
279	218	124	3/4"	3/4"

Codice /code	Descrizione /description
2220111	Proiettore di illuminazione subacquea 300 watt 12 V underwater light 300 watt 12 V
2220302	Proiettore di illuminazione subacquea 300 watt 12 V + guarnizione sandwich underwater light 300 watt 12 V + seal sandwich
2220140	Kit flangia+guarnizioni+viti proiettore 96844V kit with flange,seal and screws for sunderwater light
1070047	Lampada da 300 Watts 12 Volts, standard lamp 300 watts 12 V, standard
2220201	Guarnizione sandwich sandwich seal

**MINI PROIETTORI SERIE MT-3 PER PISCINE IN CEMENTO E LINER  
MINI UNDERWATER LIGHTS MT-3 FOR CONCRETE AND LINER POOL**

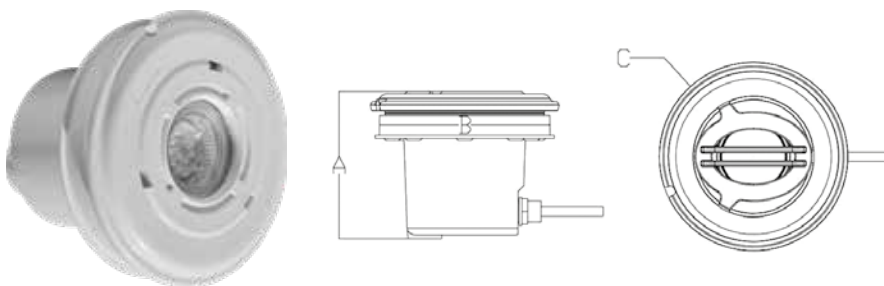

**DIMENSIONI / DIMENSIONS**

A mm	B mm	C mm
127,30	147	163,20

Codice /code	Descrizione /description
2220114	Mini proiettore di illuminazione per piccole piscine 50 Watt/12 V diam.120 mm. Flangia, guarnizioni e viti inox per tenuta della membrana di impermeabilizzazione per piscine cemento/liner mini underwater light for small pools 50 Watt/12 V Flanges, gaskets and screws for tightness of the waterproofing membrane for cement / liners pools
2220117	Mini proiettore a led, diam.120 mm, 18 unità led colore bianco con flangia, guarnizioni e viti inox per tenuta della membrana di impermeabilizzazione per piscine cemento/liner-1,5 watt/12V mini LED underwater light Ø 120 mm, 18 white led units with flange, gaskets and screws for waterproofing membrane for pool cement/liner 1,5 watt/12V
2220130	Lampada a 18 led bianco 1,5 watt/12V lamp with 18 white led 1,5 watt/12V

**MINI PROIETTORI SERIE MT-3 PER PISCINE IN PANNELLI E VETRORESINA**  
**MINI UNDERWATER LIGHTS MT-3 FOR PANEL AND FIBERGLASS POOL**

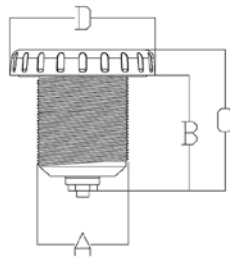

**DIMENSIONI / DIMENSIONS**

A mm	B mm	C mm	D mm
59	74,97	91,55	94,27

Codice /code	Descrizione /description
2220124	Mini proiettore senza nicchia per vasche spa o scale in resina con anello di serraggio e guarnizioni 50 watt/12V/Mini underwater light without recess for spa or stairs with locking ring and gaskets 50 watt/12V
2220115	Mini proiettore a led senza nicchia, 18 unità led colore bianco per vasche spa o scale in resina con anello di serraggio e guarnizioni 1,5 watt/12V Mini-LED underwater light without recess, 18 white led units for spa or stairs with locking ring and gaskets 1,5 watt/12V
2220130	Lampada a 18 led bianco 1,5 watt/12V Lamp with 18 white led 1,5 watt/12V
2220116	Mini proiettore a led senza nicchia, 18 unità led multicolore per vasche spa o scale in resina con anello di serraggio e guarnizioni 1,5 watt/12V Mini-LED underwater light without recess, 18 led multicolor for spa or stairs with locking ring and gaskets 1,5 watt/12V
2220131	Lampada a 18 led multicolore -MR16 1,5 watt/12V Lamp with 18 multicolor led 1,5 watt/12V

IMPIANTO/EQUIPMENT

**SCATOLA DI DERIVAZIONE**  
**DECK BOX**

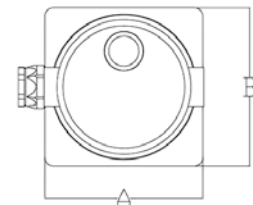
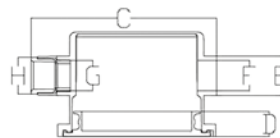
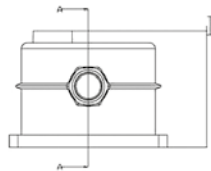

**DIMENSIONI / DIMENSIONS**

A mm	B mm	C mm	D mm	E mm	F mm	G mm	H mm	I mm
129	129	151	20,20	32,20	24,40	24,40	29,70	94,50

Codice /code	Descrizione /description
2220119	Scatola di derivazione con 3 connessioni 3/4" Deck box with 3 connections 3/4"

**FLESSIBILE PER PROIETTORE**  
**FLEXIBLE PIPE FOR UNDERWATER LIGHT**



Codice /code	Descrizione /description
2220120	Flessibile per proiettore - pezzo da 1 m - 3/4" filettato flexible tube for underwater light- 1 m to piece- threded 3/4"

SKIMMER SERIE MT-14 IN ABS PER LINER / SKIMMER MT-14 IN ABS FOR LINER



cod.2220511



cod.2220512



cod.1070810



cod.1070811

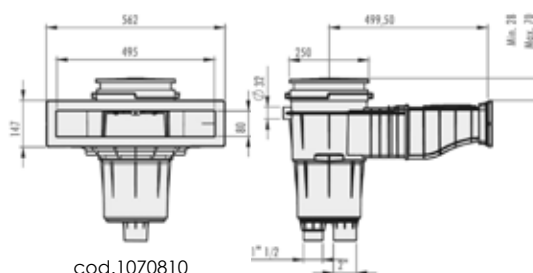

cod.1070810

Codice / code	Descrizione /description
2220511	Skimmer a bocca svasata con inserti in ottone e prolunga per liner /Wide mouth skimmer w/brass inserts and extension for liner
2220512	Skimmer a bocca svasata con inserti in ottone e prolunga per pannelli/parete sottile / Wide mouth skimmer w/brass inserts and extension for panels/thin wall
1070810	Skimmer Senior sfioratore in ABS / overflowskimmer Senior in ABS
2220518	Guarnizione sandwich skimmer a bocca svasata cod. 2220512 / sandwich seal for skimmer wide mouth
1070811	Guarnizione sandwich per skimmer senior / sandwich seal for skimmer senior

ACCESSORI PER SKIMMER SERIE MT-14 / ACCESSORIES FOR SKIMMER MT-14



cod.2220515



cod.2220516



cod.2220517

Codice /code	Descrizione /description
2220515	Prolunga skimmer skimmer throat extension
2220516	Prolunga coperchio skimmer 2220513 skimmer 2220513 cover extension
2220517	Prolunga coperchio skimmer skimmer cover extension

REGOLATORE DI LIVELLO, BOCCHETTA DI LIVELLO MT-14 / LEVEL REGULATOR, LEVEL NOZZLE MT-14



Codice /code	Descrizione /description
2220551	Regolatore di livello Level regulator

PRESA A SPAZZOLA SERIE MT-14 / VACUUM POINT MT-14



Codice /code	Descrizione /description
2220505	Pres a spazzola parete incollaggio o filettata, con inserti in ottone, per liner Vacuum point to wall threaded or gluing, with brass inserts, for liner



## BOCCHETTE DI IMMISSIONE SERIE MT-14 / RETURN FITTING MT-14



cod.2220502



cod.2220504

Codice / code	Descrizione /description
2220502	Bocchetta immissione a parete, con inserti in ottone, per liner / Wall return fitting, with brass inserts, for liner
2220504	Bocchetta immissione a parete, per vetroresina / Wall return fitting, for fiberglass

## BOCCHETTE DA FONDO SERIE MT-14 / BOTTOM INLET MT-14



cod.2220500



cod.2220501

Codice / code	Descrizione /description
2220500	Bocchetta a pavimento filettata diam. interno 50, esterno 2", inserti in ottone, per liner / Floor inlet threaded internal diam 50, external 2", brass inserts, liner
2220501	Bocchetta a pavimento a incollaggio con griglia diam. interno 63, per liner / Floor inlet glue with grid internal diam 63, liner

## POZZETTI DI FONDO SERIE MT-14 / MAIN DRAIN MT-14



cod.2220520



cod.1070033

Codice /code	Descrizione /description
2220520	Pozzetto di fondo 2"-1"½, con inserti in ottone, per liner / Main drain 2"-1"1/2, with brass inserts, for liner
1070033	Pozzetto di fondo con griglia ANTIVORTEX a norma UNI EN 13451-3 - per liner / Main drain ANTIVORTEX grating norm UNI EN 13451-3, for liner
1070081	Pozzetto di fondo ANTIVORTEX bianco C/TUBO Ø50 / Main drain ANTIVORTEX white C/TUBO Ø50
1070082	Pozzetto di fondo ANTIVORTEX bianco C/TUBO Ø62 / Main drain ANTIVORTEX white C/TUBO Ø62
1072276	Kit griglia per pozzetto di fondo ANTIVORTEX a norma UNI EN 13451-3 / Kit grating for antivortex main drain complied with UNI EN 13451-3

## PROIETTORI SERIE MT-14 / UNDERWATER LIGHT MT-14



cod.2220533



cod.2220536



cod.2220537



cod.2220519

Codice /code	Descrizione /description
2220531	Proiettore a led bianco, inserti in ottone, per liner 45W/12V / underwater light led white w/brass inserts for liner 45W/12V
2220532	Proiettore a led multicolore, inserti in ottone, per liner 45W/12V / underwater light led multicolor w/brass inserts for liner 45W/12V
2220533	Proiettore a led multicolore piatto, per liner 45W/12V / underwater light led multicolor flat for liner 45W/12V
2220519	Guarnizione Sandwich per proiettore MT-14 / sandwich seal underwater light MT-14
2220534	Mini proiettore a led bianco, inserti in ottone, per liner / mini underwater light led white w/brass inserts for liner
2220536	Mini proiettore a led multicolore, inserti in ottone, per liner / mini underwater light led multicolor w/brass inserts for liner
2220535	Mini proiettore a led bianco senza nicchia, per liner / mini underwater light led white without recess for liner
2220537	Mini proiettore a led multicolore senza nicchia, per liner / mini underwater light led multicolor without recess for liner
2220538	Telecomando per proiettori MT14 / remote control for MT14 underwater light
2220539	Scatola di comando per proiettori MT14 /receptor for MT14 underwater light

## SKIMFILTRE



cod.2220600

SKIMFILTRE combina uno skimmer a grande apertura con un filtro a cartuccia performante. Questo concetto semplifica l'installazione non richiedendo tubazione tra skimmer e filtro, con un insieme molto compatto. Il modello ELEGANCE 400 (apertura 400x200) ha una struttura rinforzata e può essere utilizzato sia interrato che installato in un muro filtrante. È equipaggiato di due troppi pieni non perforati e di un'aleffa con arresto anti-rumore.

SKIMFILTER combine a wide mouth skimmer with a performing cartridge filter. This concept considerably simplifies installation not requiring pipe between skimmer and filter, with a very compact set. The ELEGANCE 400 model (hole 400x200) has a reinforced structure and can be used both underground and installed in a wall filter. Equipped with two not perforated overflows and of a fin with stopping noise.

Codice / code	Descrizione /description
2220600	Skimfilitre Elegance 400 - portata max 20 m3/h-piscina pannelli Skimfilitre Elegance 400-max flow 20 m3/h-panels pool
2220601	Skimfilitre Classic 200 - portata max 12,5 m3/h-piscina pannelli Skimfilitre Classic 200-max flow 12,5 m3/h-panels pool
CARTUCCE DI RICAMBIO / REPLACEMENT CARTRIDGES	
2220602	Cartuccia ricambio Skimfilitre/Twinfilitre Elegance 400 Replacement cartridge for Skimfilitre/Twinfilitre Elegance 400
2220603	Cartuccia ricambio Skimfilitre Classic 200 Replacement cartridge for Skimfilitre Classic 200

## TWINFILTRE



TWINFILTRE modello di alta gamma molto performante, dotato nel primo vano, di un sacco prefiltro 500 micron di grande capacità per raccogliere le foglie e piccoli detriti. Nel secondo vano, cartuccia filtrante 15 micron per una qualità di filtrazione ottimale con una durata di servizio fino ad un mese prima della pulizia. Indicatore di colmatatura integrato.

TWINFILTRE high-end model very performant, equipped in the first tank of a prefilter bag 500 micron great capacity to collect leaves and small debris. In the second tank filtering cartridge 15 micron for a optimal filtering quality with a service life of until a month before cleaning. Topping indicator integrated.

Codice / code	Descrizione /description
2220604	Twinfilitre Elegance 400 - portata max 20 m3/h- piscina pannelli Twinfilitre Elegance 400 - max flow 20 m3/h-panels pool
CARTUCCE DI RICAMBIO / REPLACEMENT CARTRIDGES	
2220602	Cartuccia ricambio Skimfilitre/Twinfilitre Elegance 400 Replacement cartridge for Skimfilitre/Twinfilitre Elegance 400

## BOCCHETTE / NOZZLES



cod.2220610



cod.2220611



cod.2220612

Codice /code	Descrizione /description
2220610	Bocchetta di immissione con getto orientabile 1" 1/2- piscina pannelli Return fitting with orientable jet 1"1/2- panels pool
2220611	Bocchetta di presa spazzola 1" 1/2- piscina pannelli Vacuum point 1"1/2- panels pool
2220612	Griglia per presa spazzola Vacuum point grid

## PROIETTORI LED PIATTI / FLAT UNDERWATER LED LIGHTS



Proiettori senza nicchia  
Underwater lights without niche

Proiettore con o senza nicchia per piscine esistenti o per rinnovare una piscina.  
Il proiettore è dotato di flangia rotonda e quadrata.  
Alimentazione 12V AC.

*Projector with or without niche for existing pools or those who want to renew a pool.  
Projector is series delivered with a round and a square frame. Power supply 12V AC.*



Proiettori con nicchia  
Underwater lights with niche

Codice / code	Descrizione / description
2220630	Proiettore bianco 12 led bianco 30W - senza nicchia Underwater light 12 white led 30W - without niche
2220631	Proiettore bianco 12 led - RGB 28 W - senza nicchia Underwater light white 6 - RGB 28W - without niche
2220637	Proiettore 12 led bianco - piscina pannelli - con nicchia Underwater light 12 white led - panels pool - with niche
2220621	Proiettore 6 led bianco - piscina liner - con nicchia Underwater light 6 white led - liner pool - with niche

## PROIETTORE EASYLED / UNDERWATER LED LIGHT EASYLED



Progettazione e integrazione perfetta: design EXTRA piatto. Adatto a diversi tipi di piscina. Facile da installare: può essere montato su tutti gli ugelli 1"½.

*Design and seamless integration: design EXTRA flat. Suitable for different types of swimming pool. Easy to install: it can be mounted on all nozzles 1"½.*

Codice / code	Descrizione / description
2220632	Proiettore bianco 12 led bianco (2600 lumen) 36W - per bocchetta White 12-LED (2600 lumens) 36 watts - for return fitting
2220633	Proiettore bianco 12 led - RGB (850 lumen) 28 W - per bocchetta Color 12- LED (RGB)(850 lumens) 28 watts - for return fitting

## LAMPADIE UNIVERSALI A MONTAGGIO RAPIDO / UNIVERSAL LAMPS EASY TO INSTALL



LAMPADIE universali a montaggio rapido su nicchia esistente - tipo PAR 56  
UNIVERSAL LAMP easy to install on existing niche - PAR 56 type

Codice /code	Descrizione /description
2220622	Lampada 6 led bianco 19W - 1500 lumen 6 led white lamp 19 Watt - 1500 lumen
2220623	Lampada 12 led bianco 36W - 2600 lumen 12 led white lamp 36 Watt - 2600 lumen
2220625	Lampada 12 led RGB 28W - 850 lumen 12 led RGB lamp 28 W- 850 lumen

## KIT CONTROLLO REMOTO LINEA WELTICO / REMOTE CONTROLS KIT WELTICO SERIES

Codice /code	Descrizione /description
2220624	Kit di controllo remoto ON/OFF per lampade led bianco (centralina + telecomando) Remote ON/OFF control kit for led white lamps (control unit + remote control)
2220626	Kit di controllo remoto per lampada led RGB (centralina + telecomando) Remote control kit for led RGB lamps (control unit + remote control)